

SINALIZAÇÃO HORIZONTAL

DETALHE - SETAS INDICATIVAS
ESCALA: 1:50

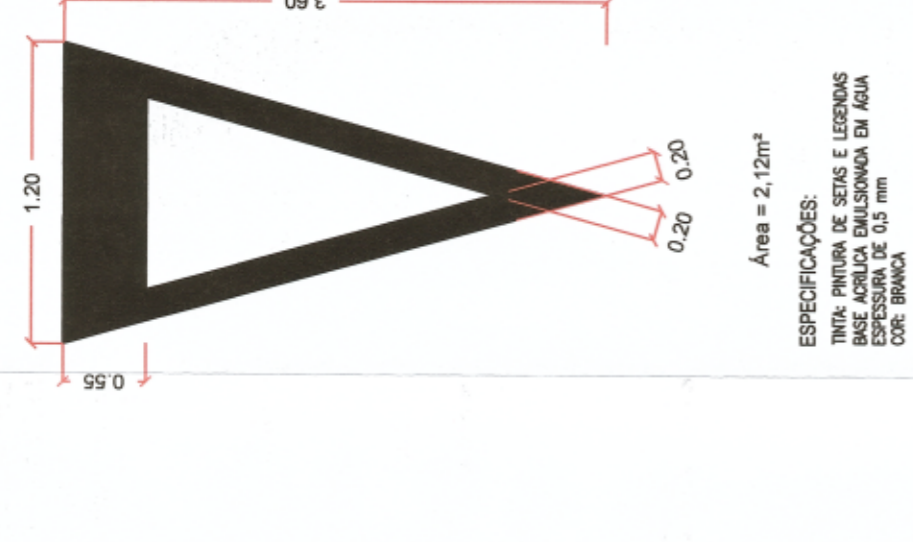

DETALHE - SETAS INDICATIVAS
ESCALA: 1:50

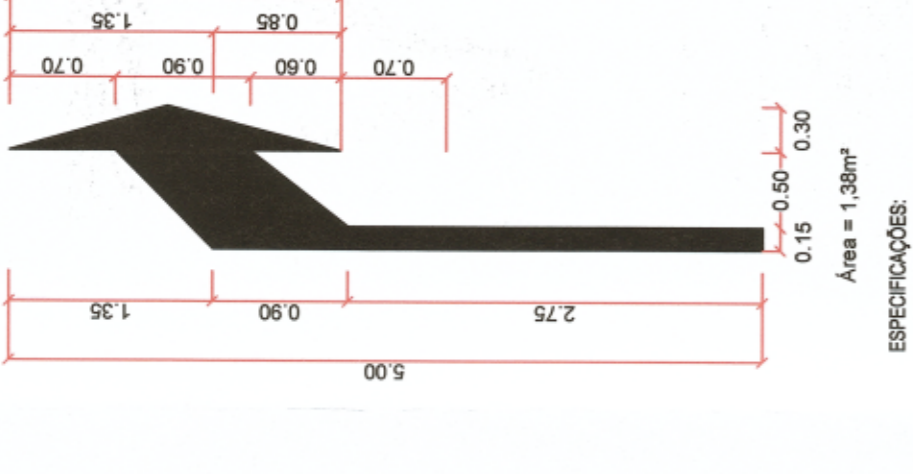

DETALHE - SETAS INDICATIVAS
ESCALA: 1:50

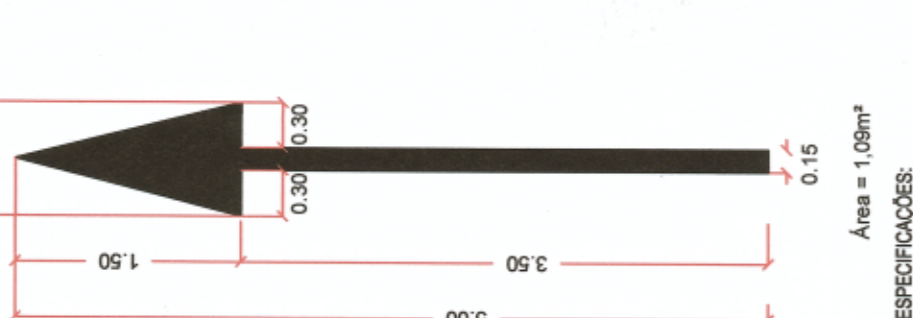

DETALHE - SETAS INDICATIVAS
ESCALA: 1:50

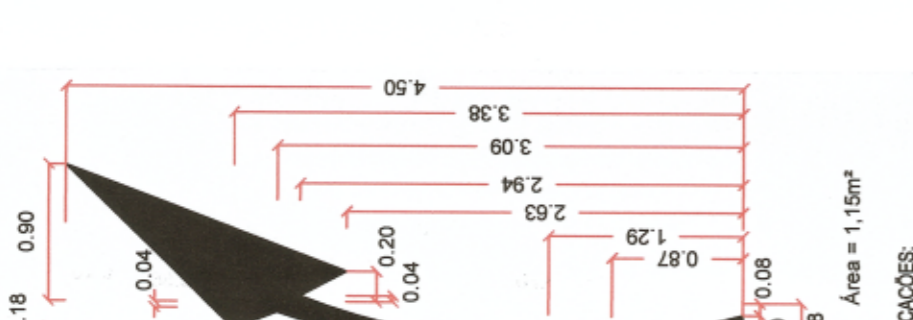

DETALHE - SETAS INDICATIVAS
ESCALA: 1:50

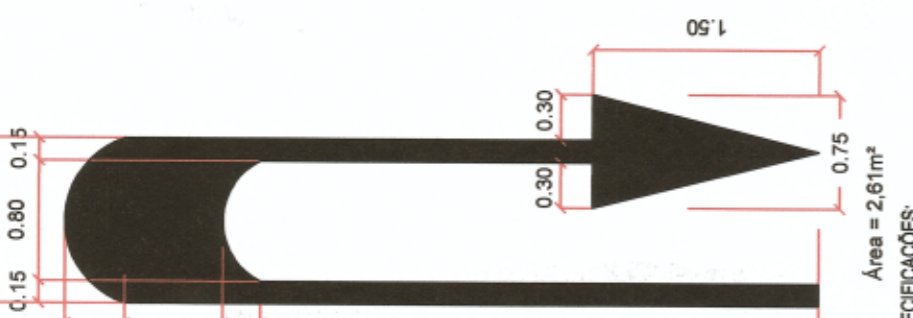

DETALHE - SETAS INDICATIVAS
ESCALA: 1:50

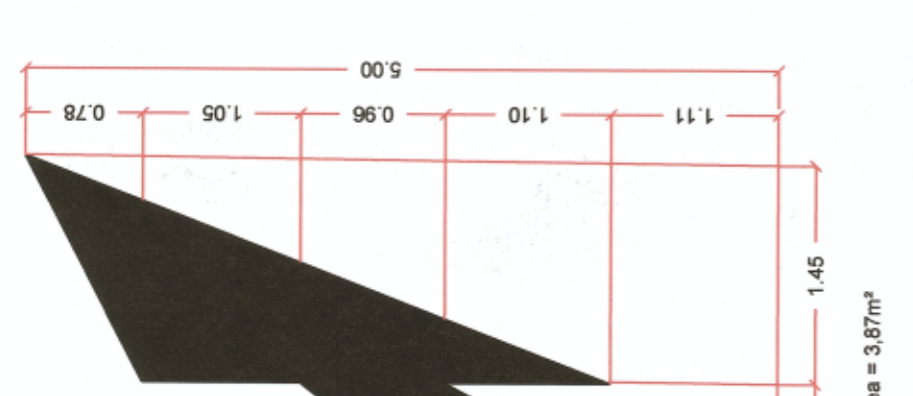

DETALHE DOS SÍMBOLOS
ESCALA: 1:50



DETALHE DOS SÍMBOLOS
ESCALA: 1:50



DETALHE DOS SÍMBOLOS
ESCALA: 1:50

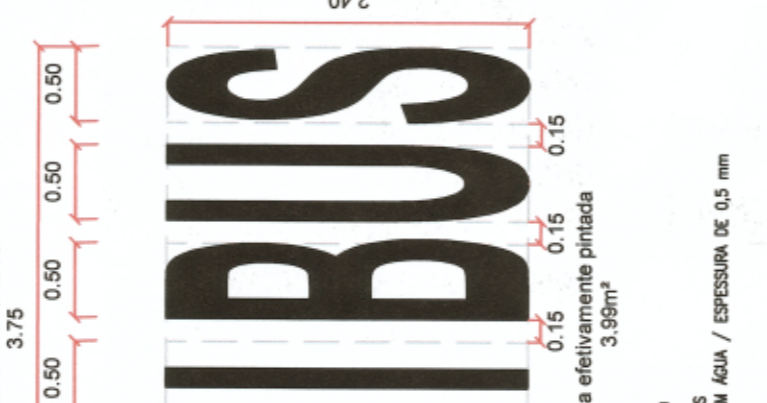

DETALHE DOS SÍMBOLOS
ESCALA: 1:50

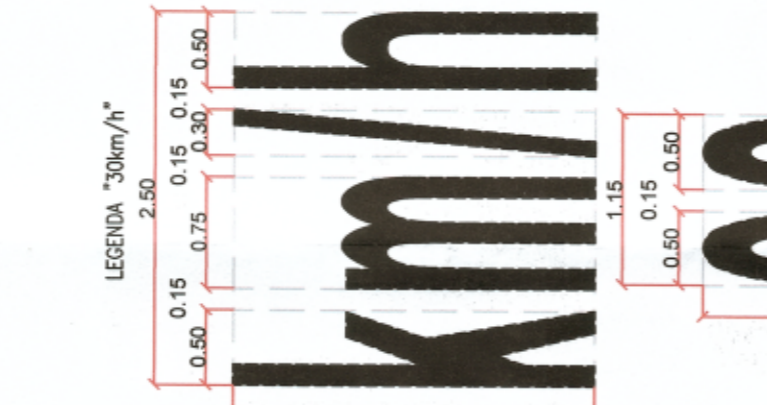

DETALHE DOS SÍMBOLOS
ESCALA: 1:50

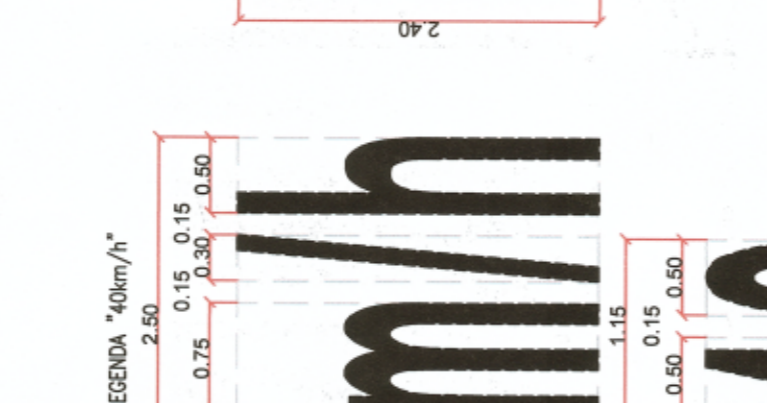

DETALHE DOS SÍMBOLOS
ESCALA: 1:50

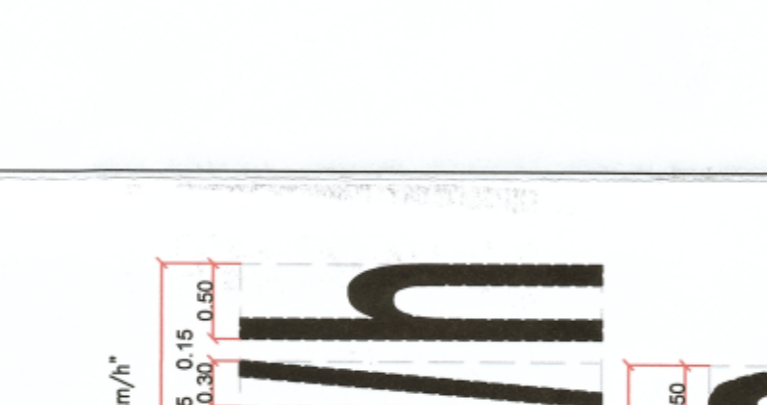

DETALHE DOS SÍMBOLOS
ESCALA: 1:50



DETALHE DOS SÍMBOLOS
ESCALA: 1:50

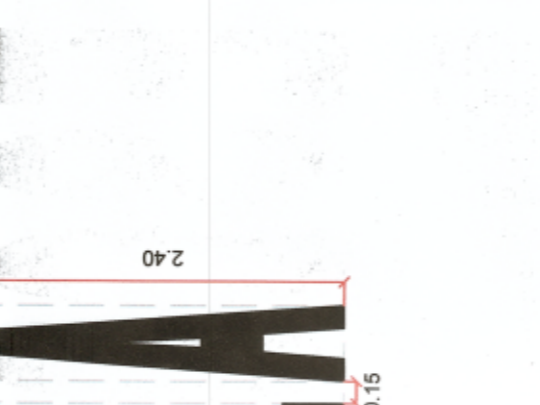

DETALHE DOS SÍMBOLOS
ESCALA: 1:50



DETALHE DOS SÍMBOLOS
ESCALA: 1:50

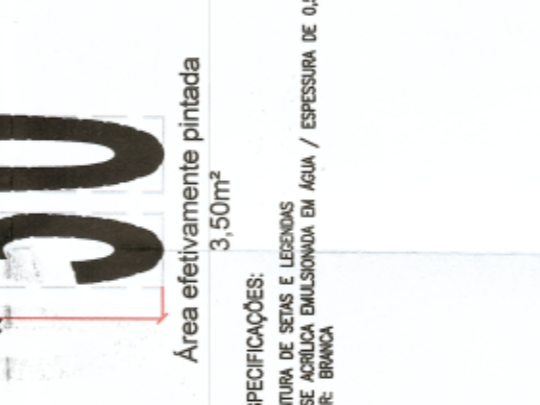

DETALHE DOS SÍMBOLOS
ESCALA: 1:50

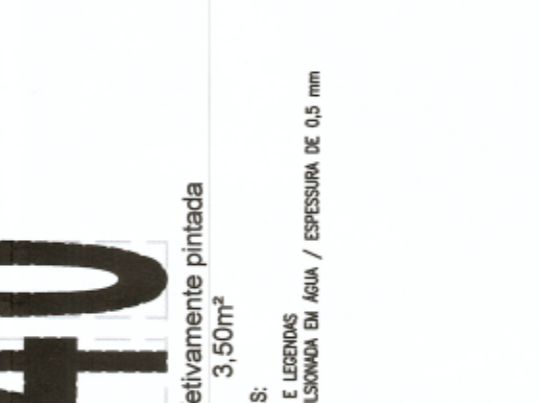

DETALHE DOS SÍMBOLOS
ESCALA: 1:50



DETALHE - SINALIZAÇÃO CICLOVIA
ESCALA: 1:50

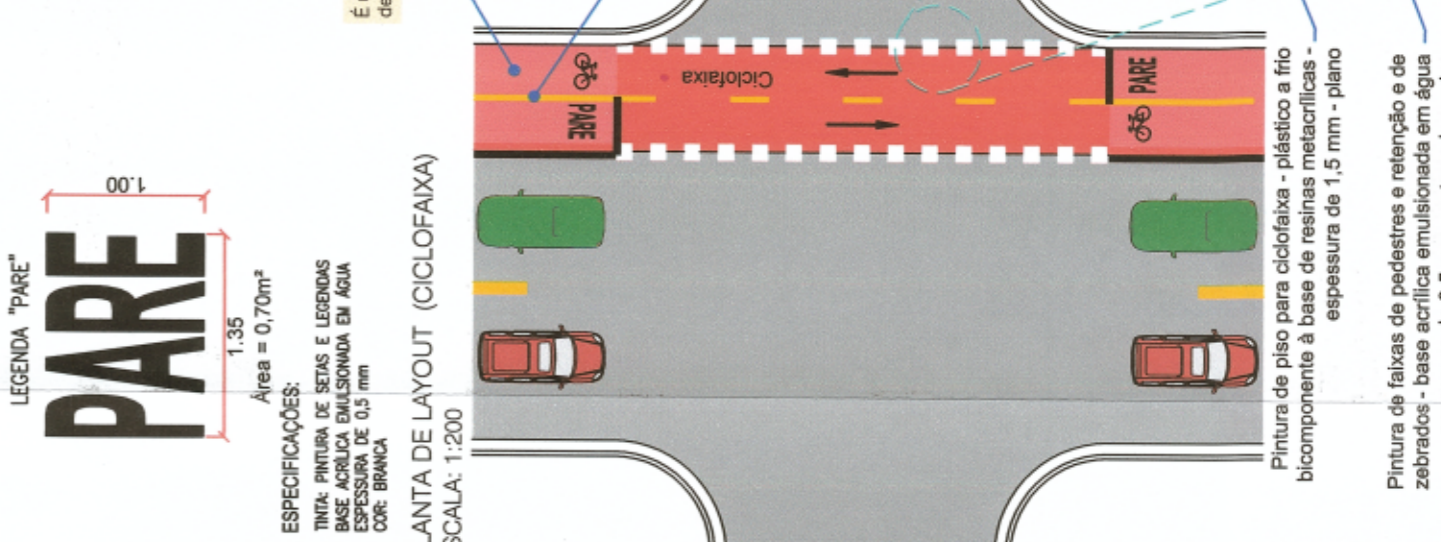

DETALHE - SINALIZAÇÃO CICLOVIA
ESCALA: 1:50

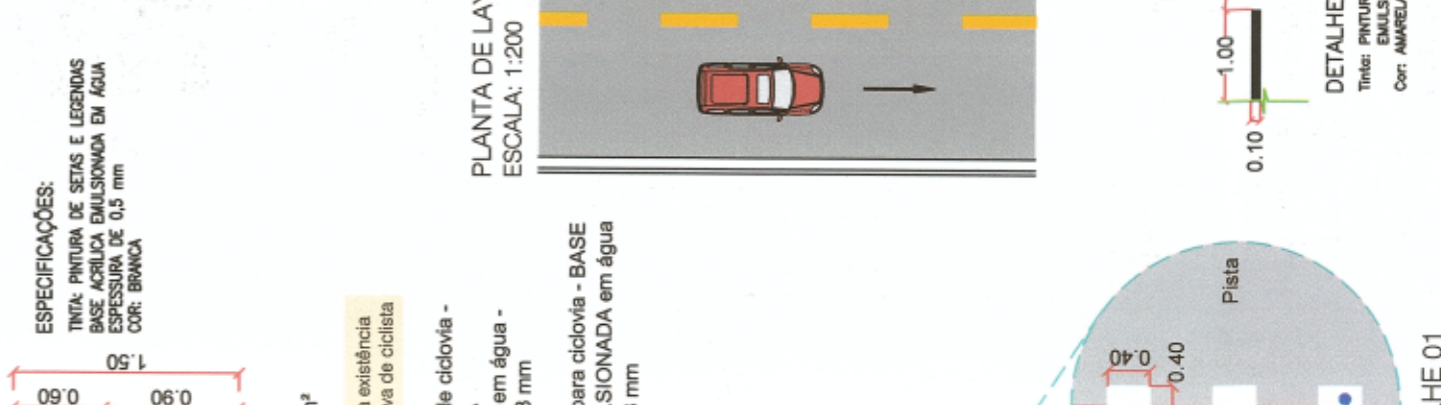

DETALHE - SINALIZAÇÃO CICLOVIA
ESCALA: 1:50

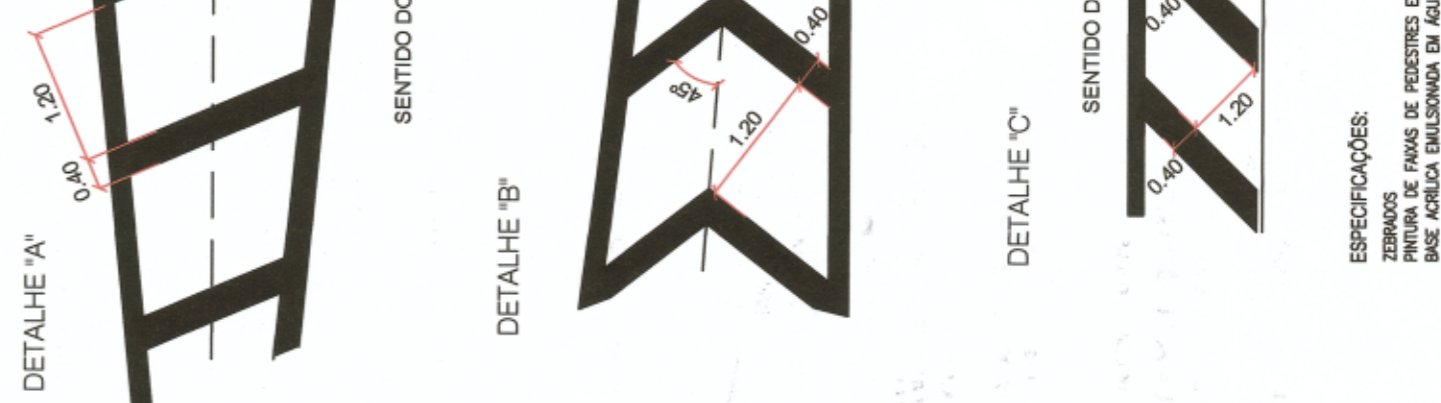

DETALHE - SINALIZAÇÃO CICLOVIA
ESCALA: 1:50

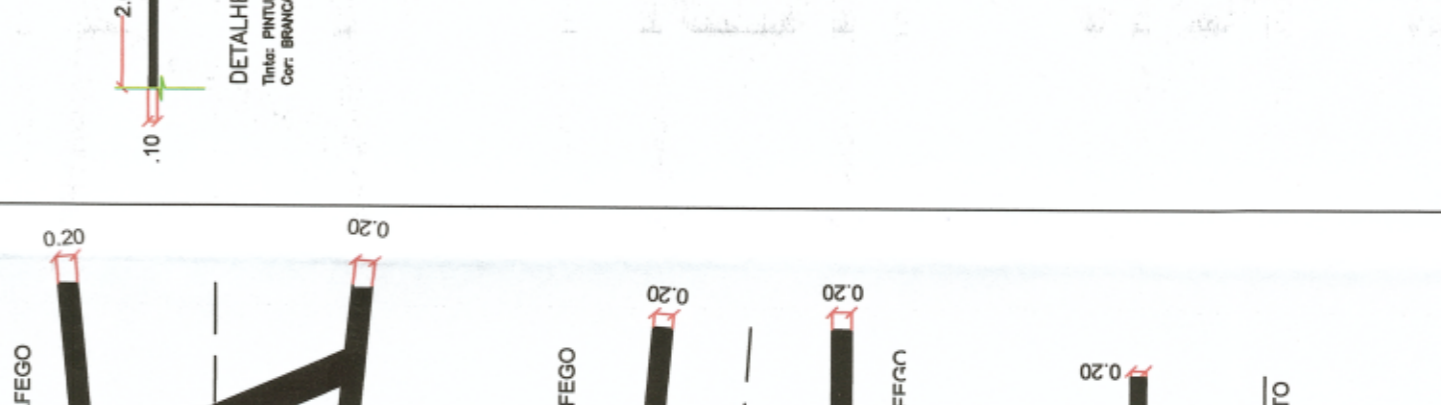

DETALHE - SINALIZAÇÃO CICLOVIA
ESCALA: 1:50

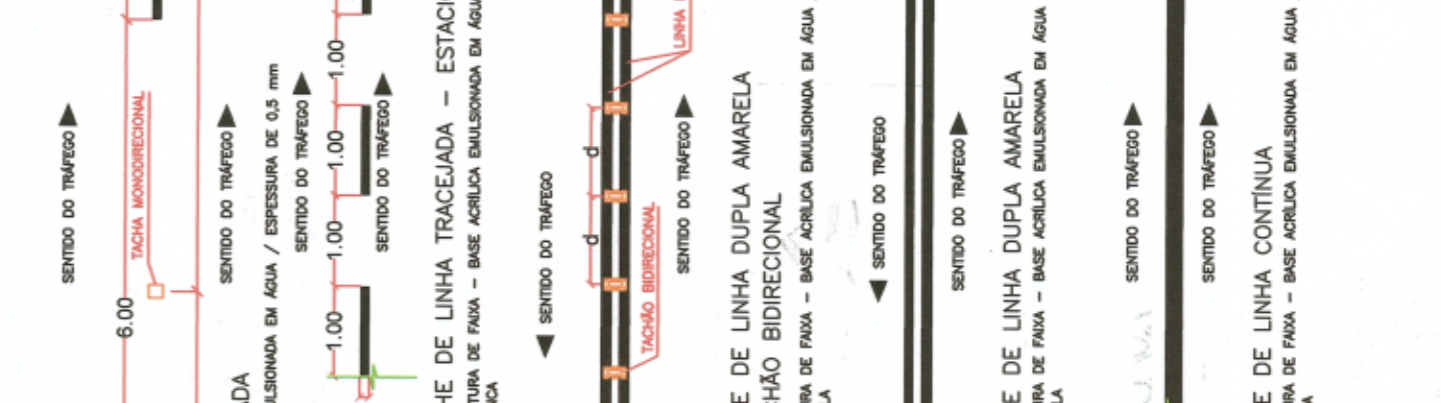

DETALHE - SINALIZAÇÃO CICLOVIA
ESCALA: 1:50

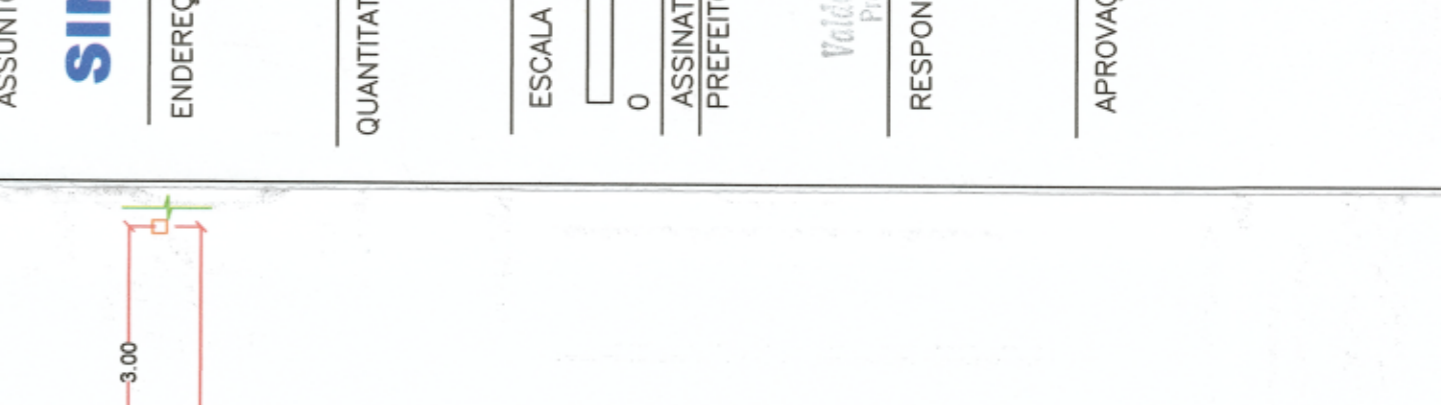

GOVERNO DE MATO GROSSO DO SUL
MUNDO NOVO
PROJETO DE INFRAESTRUTURA | 08
ASSUNTO: SINALIZAÇÃO HORIZONTAL - TIPO
ENDEREÇO/MUNICÍPIO: LOCAL: LOTEAMENTO RESIDENCIAL VALÉRIO DE MEDEIROS
ENDEREÇO: AVENIDA ADALMO SALDANHA
BAIRRO: BRENECK - MUNDO NOVO/MS.
QUANTITATIVO: TOTAL DE CONSTRUÇÃO: 90,00 Unidades
ESCALA GRÁFICA: ESCALA NOMINAL | DATA: 02/2.020
ASSINATURAS: RESPONSÁVEL TÉCNICO: Nelson T. Brito
C.P.F.:
APROVAÇÃO: PROJETO APROVADO EM 02/02/2020 de acordo com a Lei Municipal n. 160/88 PREFEITURA MUNICIPAL DE MUNDO NOVO
SECRETARIA MUNICIPAL DE OBRAS E SERVIÇOS URBANOS
Paraná, 14/04/2020